

For Earth, For Life  
Kubota

U50-5

KUBOTA Mini Excavator



# Zero-tail Swing · Boom Swing —

## Conquering the international market, Kubota mini excavator combining the zero-tail and boom swing features.

During the historic development of mini excavator market of over 30 years, the two basic conceptions, boom swing and zero-tail swing, revealed the importance for the first time in 1980s to 1990s to comply with the global need of diversified construction site. During the late 1990s, Kubota took the lead by launching its international standard mini excavator integrating both features for global market.

### ● Boom Swing

The boom swing realizes direct digging operation close to the house edge without put the machine in motion. Combined with zero-tail swing structure, the machine is very suitable for operations in tight places.

### ● Zero-tail Swing

The Kubota mini excavator adopts zero-tail swing structure. When the machine is swiveling, the tail always remains within the track width. It realizes the worry-free operation in tight places.



*Vision for tomorrow*

Over 36 years experience  
always set the latest global  
standard of mini excavator.

By the end of year **2008**, Kubota had manufactured 340,000 mini excavators in the world.

Kubota mini excavator achieved No.1 Share in the world for 7 years in a row. Kubota mini excavator promises you to experience the most advanced technology as the pioneer of mini excavator industry.

# Unique advanced functions pooling the essence of Kubota technologies

**Industry's First!**

Kubota is the first in the field of compact construction machinery to use advanced equipments such as "Auto Idle · LCD Display with Self-diagnosis Function". It's leading originality ushers the future of mini excavator.



## Auto Idling System

Save up to 10% of fuel with Kubota's Auto Idle. When the control levers are in neutral for more than 4 seconds, the engine RPM automatically idles. Move any control lever and the engine RPM immediately returns. This innovative feature reduces noise and exhaust emissions while reducing operating costs. Even in urban area and during nighttime, you may carry out operations at ease.

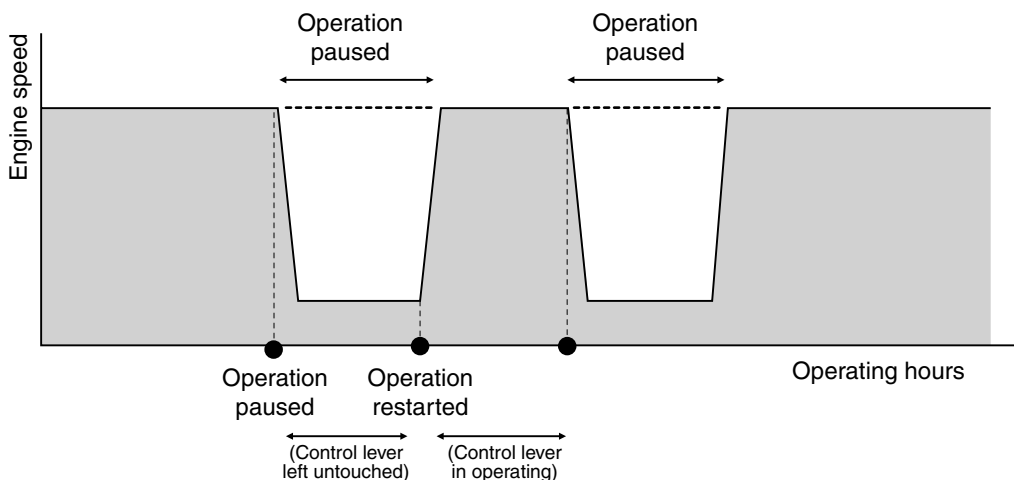
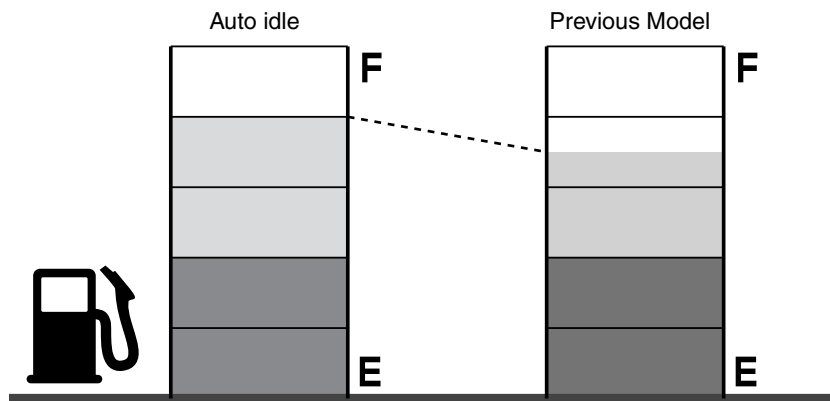



## Digital Panel

A digital panel and the Kubota Intelligent Control System (KICS) help reducing excavator downtime and repair fees by providing accurate and timely diagnostic readings and routine maintenance alerts. The panel not only lets you know when fuel is running low, but warns you during refueling when the tank is nearly full.



Instant diagnostic information is shown when an error occurs.



Describe the display content by phone.

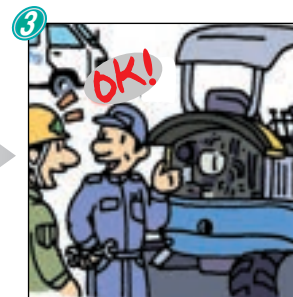

When arrive, the service staff may retrieve the error history through the display for repairing.

It is easy to notify the service staff of the situation on the jobsite through automatic indication of detected error information; Auto Save function that automatically records error history is likely to shorten time of inspection.



Example of display

- 1234.5 hours
- Engine speed: 1234 rpm
- Refill Fuel
- Abnormal charge detected Inspection required

## Smooth, Quick and Powerful Operation



Relying on its highly productive, ultra maneuverable, cost-efficient and environment-friendliness, the new hydraulic system is ready to perform efficient and powerful operation.

### The Latest Hydraulic System **3E** [EEE]

The system adjusts the hydraulic pressure according to the load changes and reacts precisely to the movement of the control lever. The various operations can be finished easily as desired by operators. Since the engine load is small, various inching and compound operations can be realized while eliminating unnecessary loss of hydraulic flow.

#### Cooperative Chart Of Control Lever and Front Attachment

- As for 3E hydraulic system, output pressure of main pump is automatically adjusted according to the load.

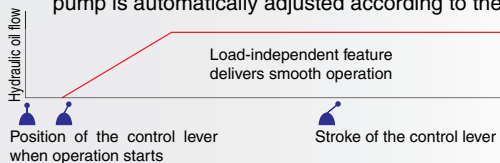

- As for traditional hydraulic system, hydraulic flow of attachment may vary according to the change of load. Inching operation will be difficult under heavy load.

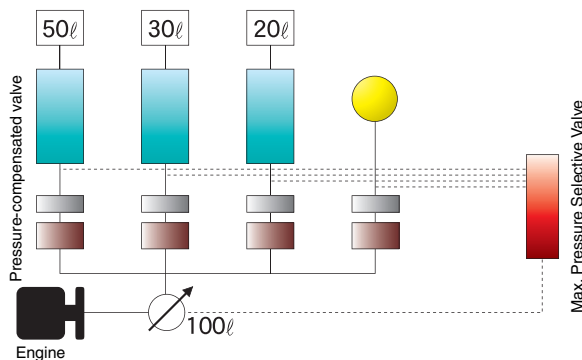
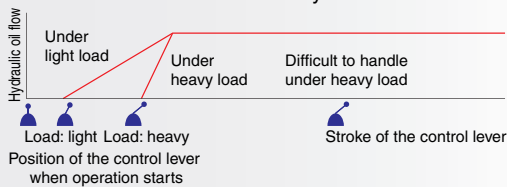

When using 3E hydraulic system, co-operation of the control lever and front attachment will be optimized, and inching operation will not be affected by load change. Any type of operations can be completed precisely.

#### Smooth Operation

Thanks to the superb matching performance of each front attachment, realizes efficient and smooth operations.

#### Travel on the Straight

The machine can travel straight even when the front attachment is operating.



#### Four Simultaneous Operations

Bucket, boom, arm and swing can be operated simultaneously and smoothly.

#### Powerful Jack-up Performance

Even under idling condition, the machine can be jacked up with the bucket or blade.

#### Prevention of Boom Lowering

Kubota's unique anti-drop valve will prevent natural lowering of boom from its lifting position.

#### "H" shaped Track Roller

The "H" shaped roller increases lateral stability and operator comfort during travel.

#### Backup Power Supply

It uses jack as same as cigarette lighter of automobile.(12V)



Backup Power Supply

High output, low fuel consumption and clean exhaust **E-TVCS** engine with world-class performance.

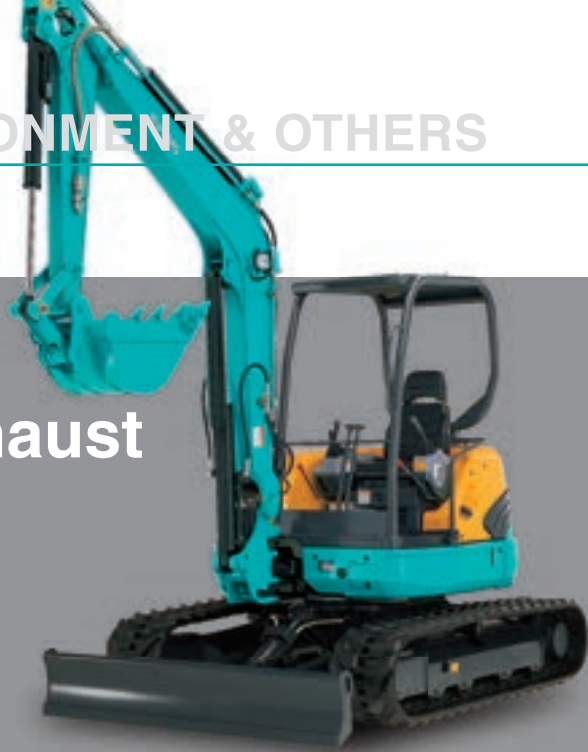

Kubota has been achieving a dominant position in the field of compact industrial diesel engine (below 100 HP).

### Clean-running Kubota Engine

Powerful and dependable, U50-5's diesel engine delivers superior horsepower and performance. It offers low noise and vibration levels, exceptional fuel efficiency, and complies with the EPA's 2008 Interim Tier IV emissions regulations.



World's  
**No.1**

Rated output: 28.8kW(39.2PS)

## World-class safety



Since 1978, Kubota has entered European and North American markets where enforce strict laws and regulations on safety. Now with remarkable achievement and experience accumulated over the years, all the know-how are all applied to the latest model to create a reliable working environment for operators.

### ROPS/FOPS Cabin

The world-class ROPS/FOPS cabin (supplied with seat belts) is used for enhanced operator safety.

#### Field Test

ROPS (ROU Over Protective Structure);FOPS (Falling Object Protective Structure). Stress analysis has been made on ROPS and FOPS. The following performance requirements can be met during field test:

- Necessary energy absorption capability
- Necessary load carrying capability
- Ensured operator safe zone
- Fastening components free of any abnormality (breakage or crack)

ROPS stress analysis graph



FOPS-1 stress analysis graph



※ Image picture

#### Wide and Comfortable Space

The cabin offers good visibility and wide space, which minimize operator fatigue even for long-hour operation.



#### Deluxe High-back Seat

#### Swivel Motor With Disk Break

When the engine shuts off, the swivel will be locked automatically. Therefore, swivel lock pin is not needed during transportation.

#### Engine Neutral Start

The engine can be started up only when the safety lever is set at locking position.



#### Engine Start Safety System

If safety lever is set at locking position, the machine will not move preventing accidents caused by mis-operation.

## Easy Maintenance



We have simplified the jobs for routine maintenance and formal inspection & service. You are able to carry out all operations at ease to keep good machine condition.

### Simple and Easy Maintenance & Service

Thanks to the full-opening rear and right side bonnets, engine, control valves, and various components are accessible for easy inspection and repair.

#### ● Right Side Bonnet

Inspection points of the hydraulic system are consolidated at the right side of the machine body for easier access.



#### ● Rear Side Bonnet

Consolidating engine components onto rear side for quicker and easier access.

#### ● Anti-collision Structure Hood and Guard Plate

Both the hood and the guard plate are located 30 mm inside the rotating part to prevent damage by accidental collision.



#### ● Boom Cylinder Protector

The new, thicker steel plated V-shaped boom cylinder protector safeguards against damage from attachments, rocks or loading.



#### ● Independent Hydraulic Hoses for Blade

Maintenance and replacement of such hoses can be carried out more easily and conveniently.



#### ● Being the First in the Industry that uses Water-proof Electrical System

Supplied with sleeve, the highly water-proof electrical joint proves to be a preventive countermeasure against electrical system failures.



#### ● Fuel Tank Drain Valve

Fuel tank drainage is simple and convenient.

#### ● Double Air Filter Structure

Such structure is to keep intake system clean.

#### ● Built-in Hoses for Attachment

With such design, hoses are safe from damage during operation.

#### ● "X"-shaped Frame + Slanted Track Frame

Both components are designed to reduce soil accumulation on track frame.

#### ● Prolonged Interval of Engine Oil Filter Element Replacement

Interval of replacement extended from 250 hours to 500 hours.

#### ● Pilot System with Pipeline Filter

Pilot filter element is provided to prevent failures caused by clogged operation circuit.

# Kubota Mini Excavator Active in Singapore

Kubota mini excavator is widely used in various construction fields such as road, municipal works, pipe networks, gardening and water conservancy combining with the use of multiple attachments. You may carry out operations at ease under various special conditions and construction environments. The real world-class Kubota mini excavator is ready to take any challenge.



## Working Range of U50-5

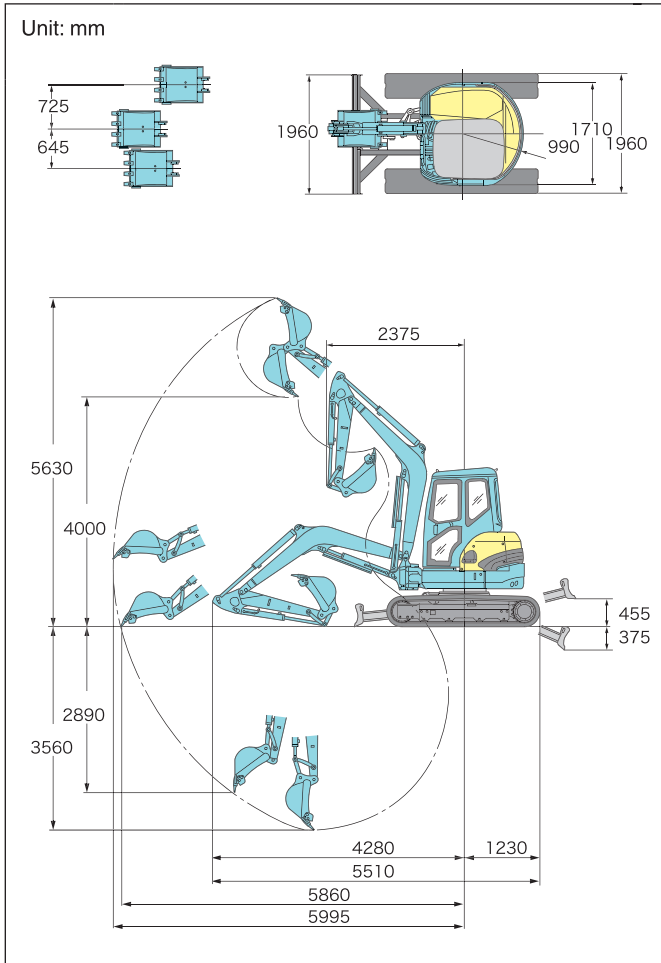

## Specifications

|   |   |                                   |
|---|---|-----------------------------------|
| Model   |   | U50-5                             |
| Bucket capacity                                 |   | m <sup>3</sup> 0.16               |
| Std. bucket width: (with/without cutting blade) |   | mm 650/600                        |
| Operating weight                                |   | Kg 4,765                          |
| Dimensions<br>(In transport condition)          | Overall length                            | mm 5,510                          |
|   | Overall height                            | mm 2,540                          |
|   | Overall width                             | mm 1,960                          |
|   | Min. ground clearance                     | mm 320                            |
| Engine  | Model                                     | Kubota V2203-M-E3-BM-SG1          |
|   | Total displacement                        | L (mL) 2,197(2,197)               |
|   | Rated output                              | kW (HP) 28.8(39.2)/2,250 rpm      |
| Digging Capacity                                | Max. digging height                       | mm 5,630                          |
|   | Max. dumping height                       | mm 4,000                          |
|   | Max. digging depth                        | mm 3,560                          |
|   | Max. vertical wall digging depth          | mm 2,890                          |
|   | Max. digging radius                       | mm 5,995                          |
|   | Boom swing: right/left                    | degree 75/48                      |
|   | Min. slewing radius of front part (swing) | mm 2,375(1,875)                   |
| Min. slewing radius of rear part                | mm 990                                    |                                   |
| Max. digging force (bucket)                     | kN (kgf) 36.5(3,720)                      |                                   |
| Track type                                      |   | Steel                             |
| Track width                                     |   | mm 400                            |
| Travel section                                  | Overall length of track                   | mm 2,500                          |
|   | Wheel base                                | mm 1,990                          |
|   | Track gauge                               | mm 1,560                          |
|   | Travel speed (1st/2nd gear)               | km/h 2.4/4.2                      |
|   | Gradeability                              | degree 30                         |
| Swing speed                                     |   | rpm 8.6                           |
| Blade   | Blade (width)                             | mm 1,960                          |
|   | Blade (height)                            | mm 360                            |
|   | Lift height (GL up/down)                  | mm 455/375                        |
| Hydraulic pump type                             |   | Variable pump × 1 + gear pump × 1 |
| Swing motor type                                |   | Hydraulic piston motor            |
| Travel motor type                               |   | Hydraulic piston motor: 2F        |
| Fuel tank capacity                              |   | L 64                              |

● Specifications in this catalog are subject to change without prior notice.





Kubota



陸機械私人有限公司  
**LAND EQUIPMENT PTE LTD**

32 JOO KOON ROAD SINGAPORE 628985

TEL: (65) 6862-5223 FAX: (65) 6861-5223

E-Mail: [sales@land-equipment.com.sg](mailto:sales@land-equipment.com.sg)

Website: <http://www.land-equipment.com.sg>